

GENERAL CHARACTERISTICS

The principle of operation of these instruments is based on the drive of one or more magnetic reed contacts, placed inside of the measuring rod, by one or more floats. The only moving element is the float that moves, for buoyancy, along the measuring rod, this guarantees extreme robustness and a limited need for maintenance.

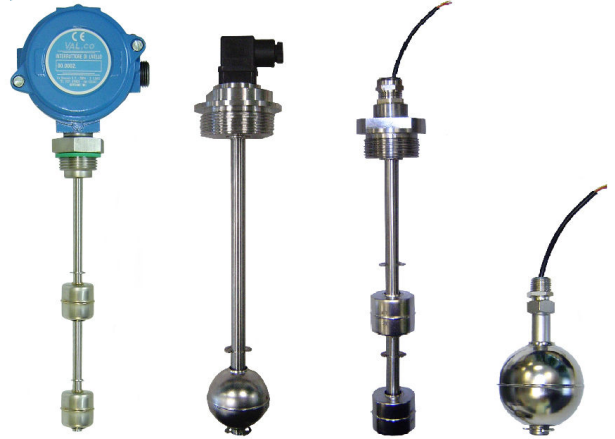

- **Stainless steel – AISI 316**
- Up to 6 switch points. - Up to 6 m length.
- Working pressure up to 50 bars depending on the used float.
- Operating ambient temperature -30/+55°C UR 90%
- Standard working temperature 105°C
- Executions up to 180°C on request.
- Minimum degree of protection IP65
- Built-in temperature sensors, on request.
PT – PTC – NTC – Thermostat.
- ATEX constructions (See Multipoint E – Multipoint I series)

FLOATS

Tab.1



Material	Stainless steel – AISI 316									
Specific gravity	0,75		0,55		0,65		0,7		0,6	
Contact type	3	7D	3	7D	4	7	4	7	7	
Max N. of contacts	6	4	6	4	6		6		6	
Max. bar	30		10		10		50		15	
Max. °C - Class					L = 105°C					
On request	N = 130°C - S1 and S2 outputs				R = 150°C				H = 180°C	

ELECTRICAL CONTACTS

Tab.2

TYPE	POWER		VOLTAGE		CURRENT	
	VA	W	AC	DC	AC	DC
SPST 3	70	50	300	350	0,5	0,7
SPST 4	80	80	250	250	1,3	1,3
SPDT 7	60	60	230	230	1	1
SPDT 7D	20	20	150	150	0,5	0,5

ELECTRICAL OUTPUT

Tab.3

W1	W2	S1 – S2	C1 – C2 – T1	P1 – P2
IP65 Housing	IP65 Housing	DIN IP65 Plug	Cable – Leads	Cable-gland
Max. 5 terminals	Max. 18 terminals	S1 DIN43650 29x29 S2 DIN43650 15x15	C1 Cable L = 1,5m C2 Cable L = 3,0m T1 Leads L = 1,5m	P1 Brass IP68 P2 Polyamide IP67

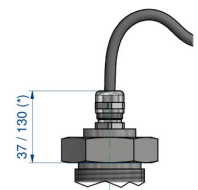
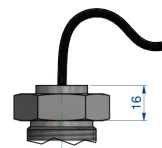
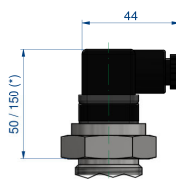
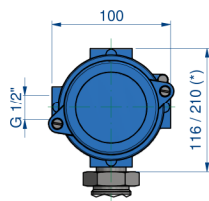
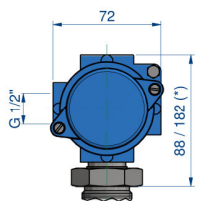

With heatsink - see overall dimension (*) W1 – W2 = Temperature class H S1– S2– P1 = Temperature class R – H

PROCESS CONNECTIONS

Tab.4

Installation from inside C- P-T output				Float type	Installation from outside – available thread and flanges						
06 1/8"	08 1/4"	10 3/8"	15 1/2"		25 1"	32 1 1/4"	40 1 1/2"	50 2"	FSHX Flange	FSPX Flange	DN Flange
All type of floats All type of thread				S29	G	G-C-N	-	-	•	•	•
				S32	G	G-C-N	-	-	•	•	•
				S41	-	-	G-C-N	G-C-N	-	-	•
				S52	-	-	-	G-C-N	-	-	•
				S100	-	-	-	-	-	-	•

Male thread

G	C	N
Parallel UNI 228/1	Conical UNI 7/1	Conical NPT

Available materials

S	T
AISI-316	AISI-304 On request

DN - Available materials

C	S
Steel	AISI-316

FLANGES

Dimensions in mm.

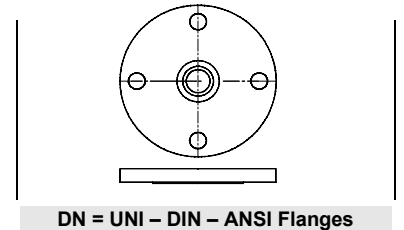
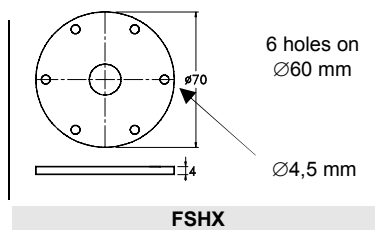
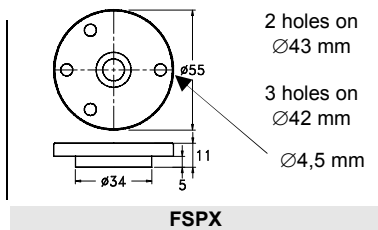

WIRING

Tab.5

I	Independent	Separately wired contacts	1	NO
C	Common	Common wired contacts	2	NC
S	Custom	Contacts wired on customer request	3	SPDT

Contacts status in no level conditions

SWITCH POINTS

Tab.6

The switch points L1 ÷ L6 are measured from the stop of the fitting or flange connection.
General tolerances on switch points ± 3 mm.

	Minimum distance in mm.									
	S29		S32		S41		S52		S100	
A	20		20		30		35		60	
A1	40		40		50		55		-	
B	25		25		35		40		70	
C	45		45		65		75		125	
Contact type	3	7D	3	7D	4	7	4	7	7	
Max. N. of contacts	6		4		6		4		6	

A Flanged connection
A1 Threaded connection

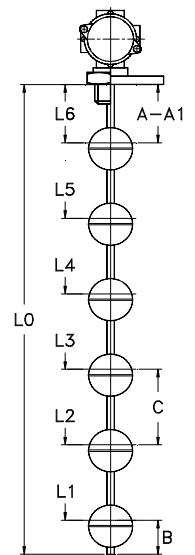

OPTION – Built-in temperature sensor

On request, it is possible to install a temperature sensor located at the bottom of the rod inside the instrument.

PT100 – PT1000	PTC	NTC	TRM (Thermostat)
EN 60751 – IEC 751	Resistance at 25°C ≤ 500 Ω	Resistance at 25°C 2-5-10-50-100 KΩ	40°C ÷ 120°C - 10°C step
Class B – (Class A on request)	Temperature 60°C ÷ 120°C	Precision ± 5% / ± 3% (on request)	Precision ± 5% Differential 10°C ± 4°C

NOMENCLATURE

M2	S41	4	1300	S	50	G	S	W1	L	I22	L1+L6	
•												Number of contacts S1 / M2+M6
	•											Tab.1 Float
		•										Tab.2 Electrical contact
			•									- Total length = L0 in mm. (See drawing)
				•								Tab.4 Rod material
					•							Tab.4 Process connection dimension
						•						Tab.4 Process connection thread
							•					Tab.4 Process connection material
								•				Tab.3 Electrical output
									•			Tab.1 Temperature class
										•		Tab.5 Wiring and contact status
											•	Tab.6 Switch points (mm)



MULTIPOINT S



Request form

External mounting

Internal mounting

W1 W2

Electrical housing IP 65
W1 max. 5 terminals 70mm
W2 max. 18 terminals 100mm

S1 S2

Plug DIN 43650
29x29 or 15x15
Max 3 terminals

P1 P2

P1 Cable-gland IP68
P2 Cable-gland IP67
L cable.....mm

C T

Cable - Leads
L.....mm

C

Only internal mounting
Cable L.....mm

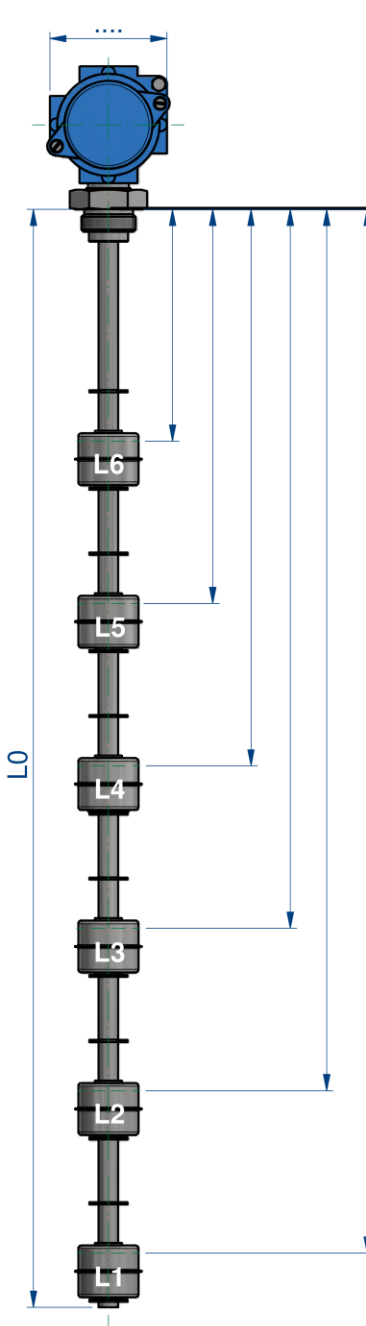

Total length
L0 (mm)

Liquid under control:

Specific gravity:

Maximum pressure:

Maximum temperature:

Approvals:



Process connection:

Threaded:..... Flanged:

Material:

Brass AISI-316 PVC PP PVDF

Wirings:

Independent contacts NO or NC (Max. 6 contacts)

Independent SPDT contacts (Max. 4 contacts)

Common wired NO or NC (Max. 6 contacts)

Common wired SPDT contacts (Max. 5 contacts)

